

DATA SHEET

NEC

GaAs INTEGRATED CIRCUIT μ PG2035T5F

GaAs MMIC DPDT SWITCH FOR 2.4 GHz AND 5 GHz DUALBAND WIRELESS LAN

DESCRIPTION

The μ PG2035T5F is a GaAs MMIC DPDT switch for 2.4 GHz and 5 GHz dualband wireless LAN. High isolation and dualband operations suit to dualband wireless LAN system.

FEATURES

- Operating frequency : $f = 2.4$ to 2.5 GHz and 4.9 to 6.0 GHz
- Low insertion loss : $L_{INS1} = 0.8$ dB TYP. @ $f = 2.4$ to 2.5 GHz
: $L_{INS2} = 1.2$ dB TYP. @ $f = 4.9$ to 6.0 GHz
- Handling power : $P_{in(1\text{ dB})} = +31$ dBm TYP. @ $f = 2.4$ to 2.5 GHz
: $+30$ dBm TYP. @ $f = 4.9$ to 6.0 GHz
- Control voltage : $V_{cont} = +3.0$ V/0 V (Two control type)
- High isolation : $ISL1$ (INPUT to OUTPUT) = 34 dB TYP. @ $f = 2.4$ to 2.5 GHz
: $ISL2$ (INPUT to OUTPUT) = 33 dB TYP. @ $f = 4.9$ to 6.0 GHz
: $ISL3$ (TX to RX, ANT1 to ANT2) = 24 dB TYP. @ $f = 2.4$ to 2.5 GHz
: $ISL4$ (TX to RX, ANT1 to ANT2) = 22 dB TYP. @ $f = 4.9$ to 6.0 GHz
- Input/output return loss : $RL_{in}/RL_{out} = 15$ dB TYP.
- Switching speed : 50 ns @ t_{RISE}/t_{FALL} (10/90% RF)
- 12-pin plastic QFN package ($3.0 \times 3.0 \times 0.75$ mm)

APPLICATION

- 2.4 GHz and 5 GHz dualband wireless LAN: IEEE802.11a+b/g

★ ORDERING INFORMATION

Part Number	Order Number	Package	Marking	Supplying Form
μ PG2035T5F-E2	μ PG2035T5F-E2-A	12-pin plastic QFN (Pb-Free)	2035	<ul style="list-style-type: none">• Embossed tape 8 mm wide• Pin 1 indicates roll-in direction of tape• Qty 3 kpcs/reel

Remark To order evaluation samples, contact your nearby sales office.

Part number for sample order: μ PG2035T5F

Caution Observe precautions when handling because these devices are sensitive to electrostatic discharge.

The information in this document is subject to change without notice. Before using this document, please confirm that this is the latest version.
Not all devices/types available in every country. Please check with local NEC Compound Semiconductor Devices representative for availability and additional information.

PIN CONNECTIONS AND INTERNAL BLOCK DIAGRAM

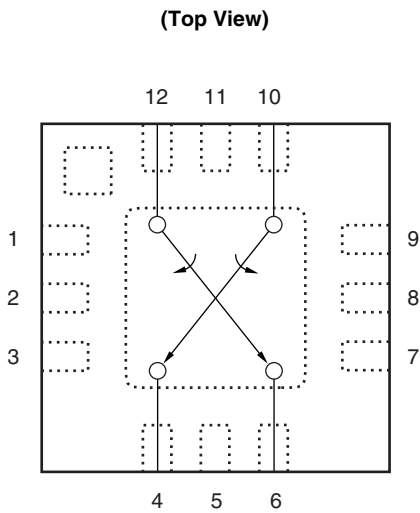

Pin No.	Pin Name	Description
1	NC	Ground
2	NC	Ground
3	V _{cont1}	Control 1
4	ANT1	Antenna Port 1
5	NC	Ground
6	ANT2	Antenna Port 2
7	V _{cont2}	Control 2
8	NC	Ground
9	NC	Ground
10	RX	Receive Port
11	NC	Ground
12	TX	Transmit Port
EXPOSED PAD	GND	Ground

Remark NC is functionally non-connection pin but actually grounding is recommended.

TRUTH TABLE

V _{cont1}	V _{cont2}	ANT1-RX	ANT1-TX	ANT2-TX	ANT2-RX
2.7 to 5.0 V	0 ± 0.2 V	ON	OFF	ON	OFF
0 ± 0.2 V	2.7 to 5.0 V	OFF	ON	OFF	ON

ABSOLUTE MAXIMUM RATINGS (T_A = +25°C, unless otherwise specified)

Parameter	Symbol	Ratings	Unit
Switch Control Voltage	V _{cont}	-6.0 to +6.0 ^{Note 1}	V
Input Power	P _{in}	+36	dBm
Total Power Dissipation	P _{tot}	0.15 ^{Note 2}	W
Operating Ambient Temperature	T _A	-45 to +85	°C
Storage Temperature	T _{stg}	-55 to +150	°C

Notes 1. |V_{cont1} - V_{cont2}| ≤ 6.0 V

2. Mounted on double-sided copper-clad 50 × 50 × 1.6 mm epoxy glass PWB, T_A = +85°C

RECOMMENDED OPERATING RANGE (TA = +25°C)

Parameter	Symbol	MIN.	TYP.	MAX.	Unit
Operating Frequency 1	f1	2.4	–	2.5	GHz
Operating Frequency 2	f2	4.9	–	6.0	GHz
Switch Control Voltage (H)	V _{cont (H)}	2.7	3.0	5.0	V
Switch Control Voltage (L)	V _{cont (L)}	–0.2	0	0.2	V

ELECTRICAL CHARACTERISTICS (TA = +25°C, V_{cont} = 3.0 V/0 V, Zo = 50 Ω, DC block capacitor = 4 pF, each port, unless otherwise specified)

Parameter	Symbol	Test Conditions	MIN.	TYP.	MAX.	Unit
Insertion Loss 1	L _{INS1}	f = 2.4 to 2.5 GHz	–	0.8	1.0	dB
Insertion Loss 2	L _{INS2}	f = 4.9 to 6.0 GHz	–	1.2	1.4	dB
Isolation 1 (INPUT to OUTPUT)	ISL1	f = 2.4 to 2.5 GHz	25	34	–	dB
Isolation 2 (INPUT to OUTPUT)	ISL2	f = 4.9 to 6.0 GHz	25	33	–	dB
Isolation 3 (TX to RX, ANT1 to ANT2)	ISL3	f = 2.4 to 2.5 GHz	17	24	–	dB
Isolation 4 (TX to RX, ANT1 to ANT2)	ISL4	f = 4.9 to 6.0 GHz	17	22	–	dB
Input and Output Return Loss 1	RL1	f = 2.4 to 2.5 GHz	–	15	–	dB
Input and Output Return Loss 2	RL2	f = 4.9 to 6.0 GHz	–	15	–	dB
Switch Control Current 1	I _{cont1}	f = 2.4 to 2.5 GHz	–	0.7	1.5	μA
Switch Control Current 2	I _{cont2}	f = 4.9 to 6.0 GHz	–	0.7	1.5	μA
1 dB Gain Compression Input Power	P _{in (1 dB)}	f = 2.4 to 2.5 GHz	–	31	–	dBm
		f = 4.9 to 6.0 GHz	–	30	–	
3rd Order Distortion Input Intercept Point 1	IIP ₃₁	f = 2.4 to 2.5 GHz	–	45	–	dBm
3rd Order Distortion Input Intercept Point 2	IIP ₃₂	f = 4.9 to 6.0 GHz	–	45	–	dBm
Switch Control Speed 1	t _{sw1}	f = 2.4 to 2.5 GHz, t _{RISE} /t _{FALL} (10/90% RF)	–	50	–	ns
Switch Control Speed 2	t _{sw2}	f = 4.9 to 6.0 GHz, t _{RISE} /t _{FALL} (10/90% RF)	–	50	–	ns

EVALUATION CIRCUIT

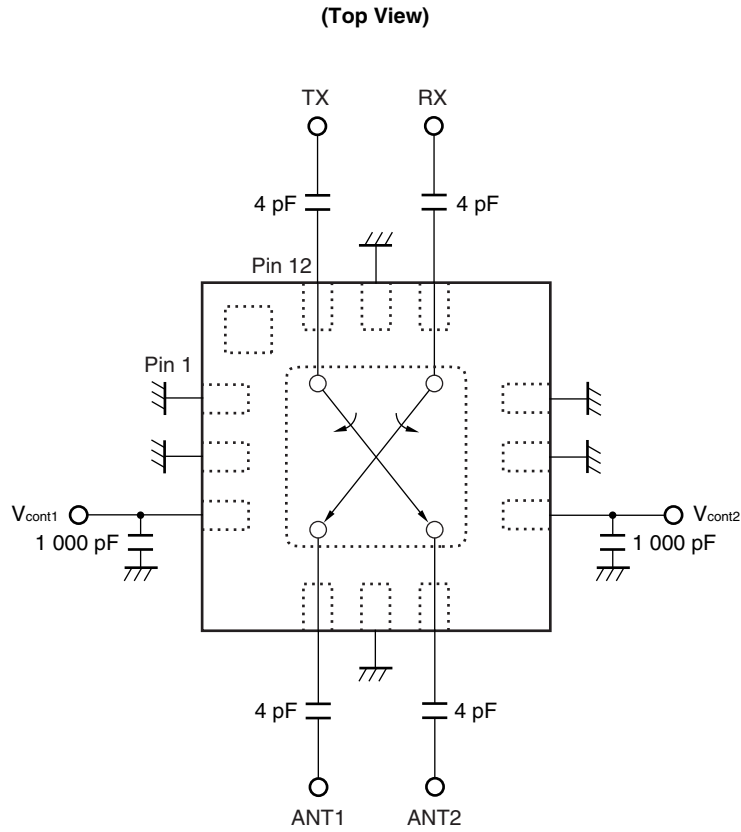

The application circuits and their parameters are for reference only and are not intended for use in actual design-ins.

★ ILLUSTRATION OF THE TEST CIRCUIT ASSEMBLED ON EVALUATION BOARD

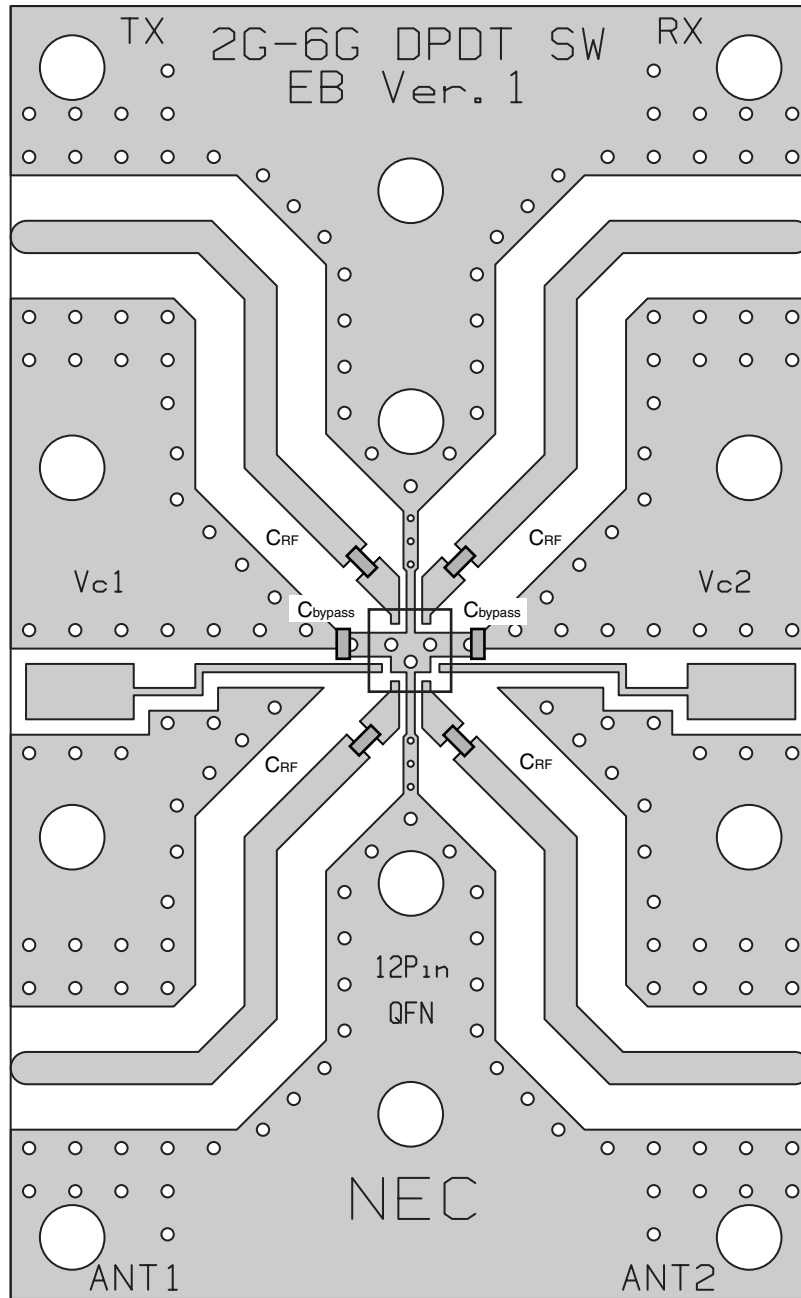

USING THE NEC EVALUATION BOARD

Symbol	Form	Rating	Part Number	Manufacturer
CRF	Chip Capacitor	4 pF	GRM1552C1H4R0CZ01B	muRata
Cbypass	Chip Capacitor	1 000 pF	GRM155B11H102KA01B	muRata
-	PC Terminal	-	A2-2PA-2.54DSA	Hirose
-	RF Connector	-	142-0721-821	Johnson
-	PWB	-	RO4003 (t = 0.51 mm)	Rogers

★ **TYPICAL CHARACTERISTICS** ($T_A = +25^{\circ}\text{C}$, $V_{\text{cont}} = 3.0 \text{ V/0 V}$, $Z_0 = 50 \Omega$, DC block capacitor = 4 pF using test fixture, unless otherwise specified)

TX-ANT1 INSERTION LOSS vs. FREQUENCY
(When TX-ANT1 and ANT2-RX are ON)

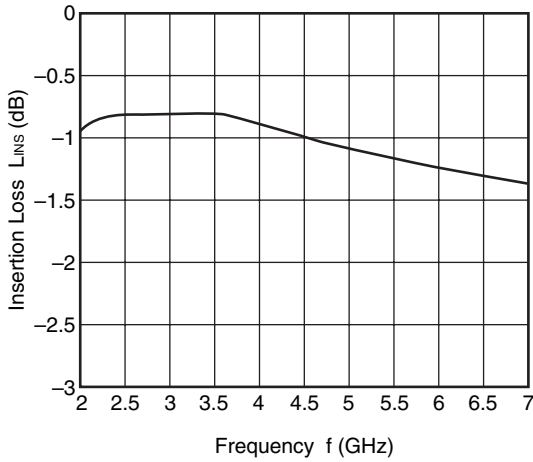

ANT1-RX INSERTION LOSS vs. FREQUENCY
(When TX-ANT2 and ANT1-RX are ON)

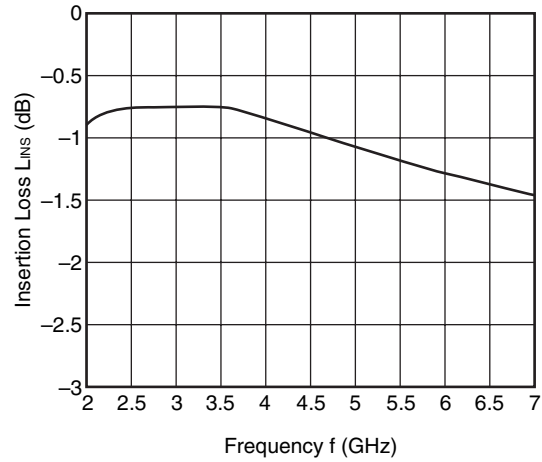

TX-ANT2 INSERTION LOSS vs. FREQUENCY
(When TX-ANT2 and ANT1-RX are ON)

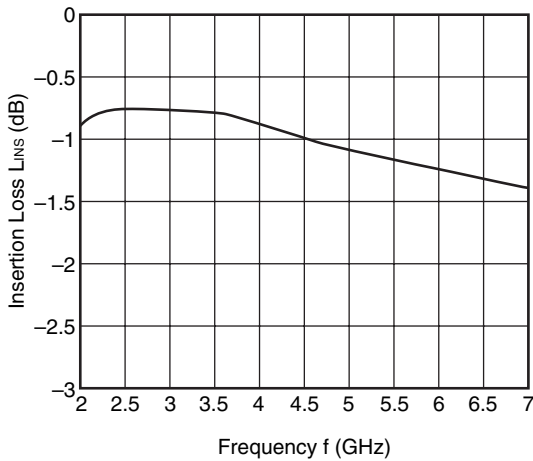

ANT2-RX INSERTION LOSS vs. FREQUENCY
(When TX-ANT1 and ANT2-RX are ON)

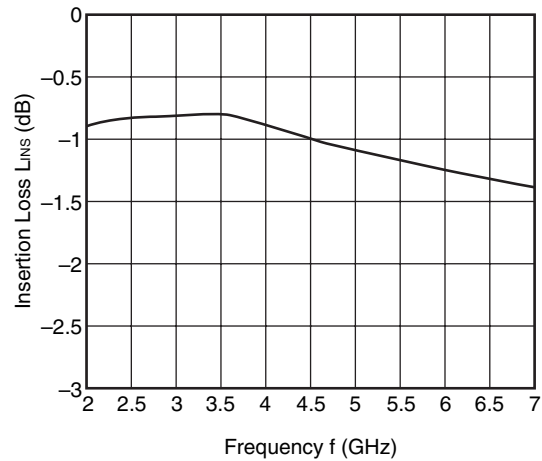

TX-RX ISOLATION vs. FREQUENCY
(When TX-ANT2 and ANT1-RX are ON)

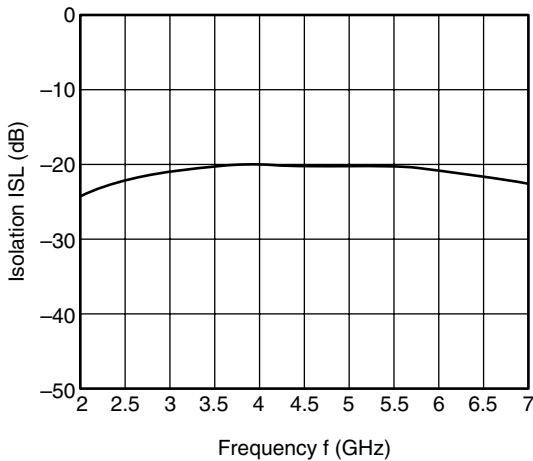

TX-RX ISOLATION vs. FREQUENCY
(When TX-ANT1 and ANT2-RX are ON)

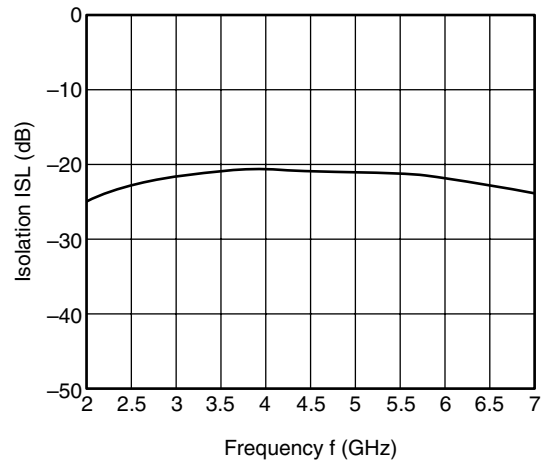

Remark The graphs indicate nominal characteristics.

TX-ANT1 ISOLATION vs. FREQUENCY
(When TX-ANT2 and ANT1-RX are ON)

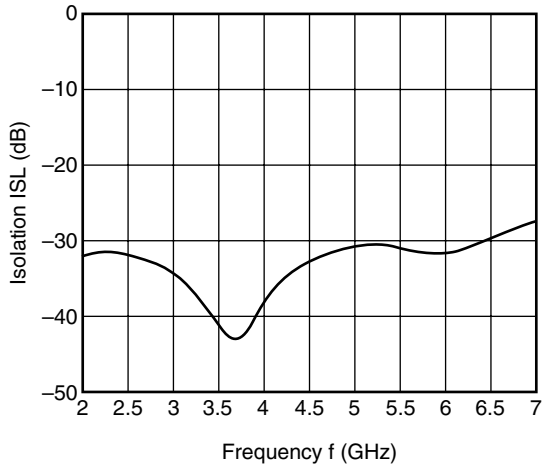

ANT1-RX ISOLATION vs. FREQUENCY
(When TX-ANT1 and ANT2-RX are ON)

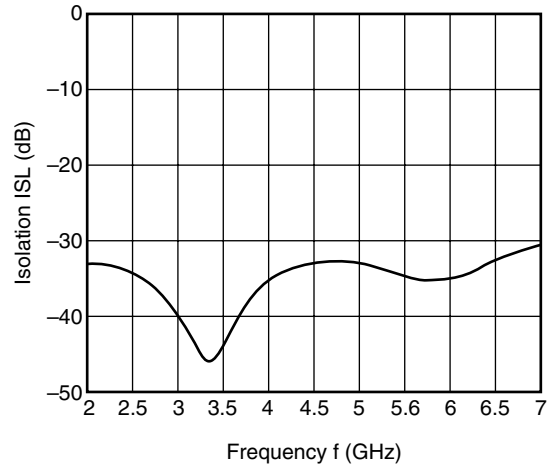

TX-ANT2 ISOLATION vs. FREQUENCY
(When TX-ANT1 and ANT2-RX are ON)

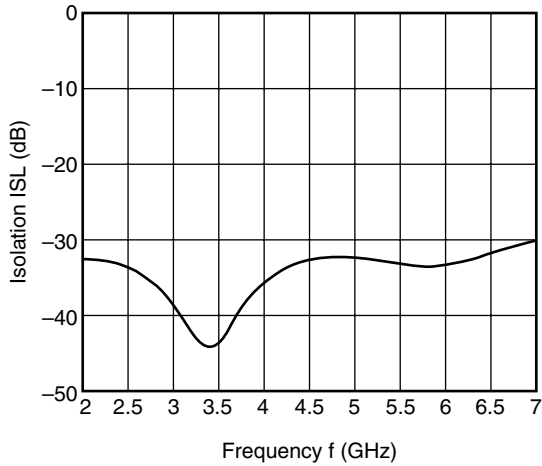

ANT2-RX ISOLATION vs. FREQUENCY
(When TX-ANT2 and ANT1-RX are ON)

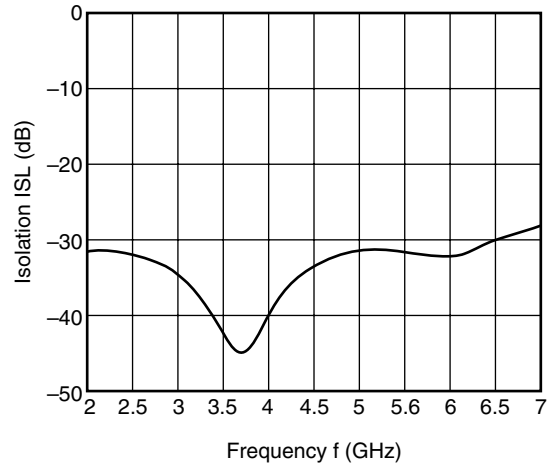

TX-ANT1 INPUT RETURN LOSS vs. FREQUENCY
(When TX-ANT1 and ANT2-RX are ON)

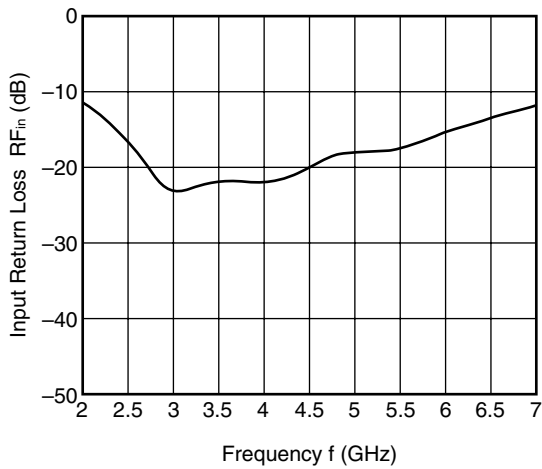

ANT1-RX OUTPUT RETURN LOSS vs. FREQUENCY
(When TX-ANT2 and ANT1-RX are ON)

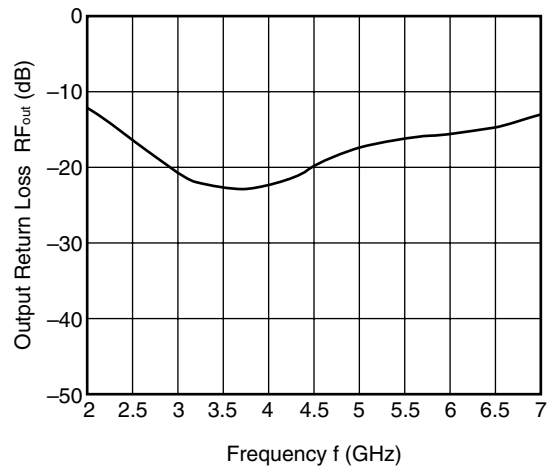

Remark The graphs indicate nominal characteristics.

TX-ANT2 INPUT RETURN LOSS vs. FREQUENCY
(When TX-ANT2 and ANT1-RX are ON)

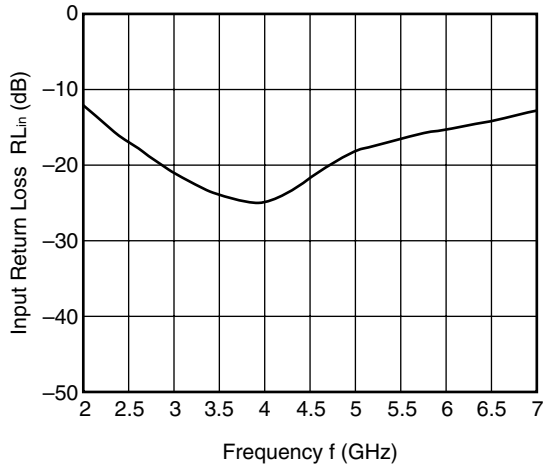

ANT2-RX OUTPUT RETURN LOSS vs. FREQUENCY
(When TX-ANT1 and ANT2-RX are ON)

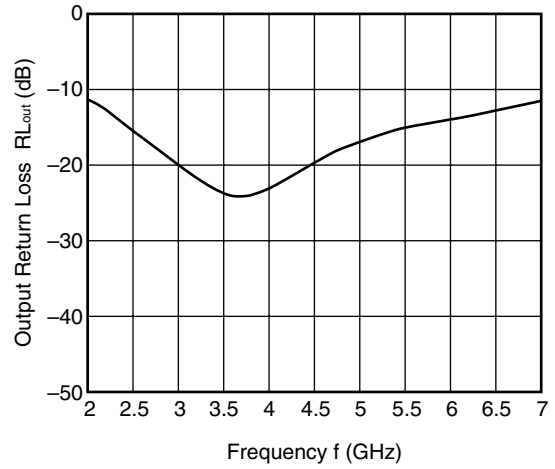

TX-ANT1 OUTPUT RETURN LOSS vs. FREQUENCY
(When TX-ANT1 and ANT2-RX are ON)

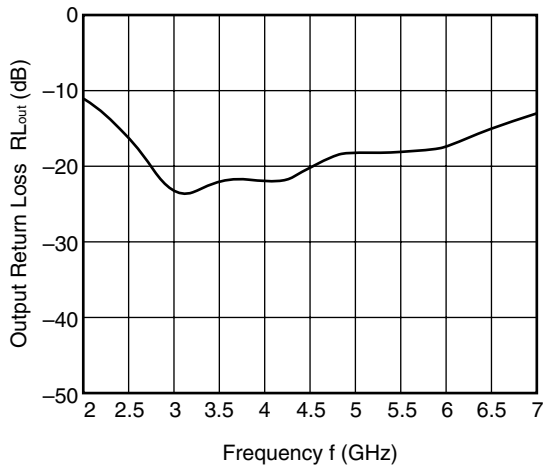

ANT1-RX INPUT RETURN LOSS vs. FREQUENCY
(When TX-ANT2 and ANT1-RX are ON)

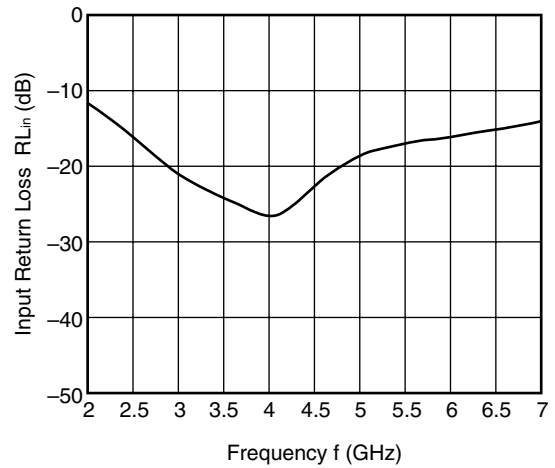

TX-ANT2 OUTPUT RETURN LOSS vs. FREQUENCY
(When TX-ANT2 and ANT1-RX are ON)

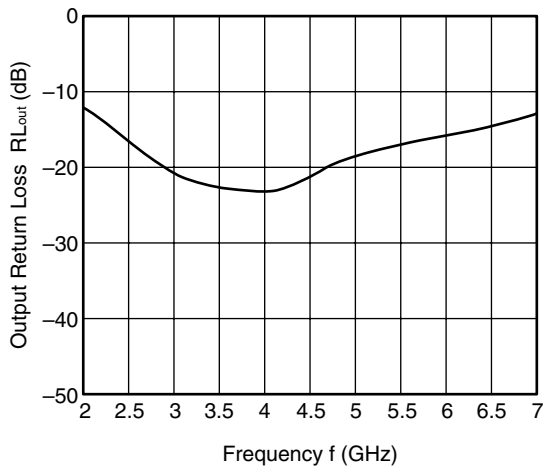

ANT2-RX INPUT RETURN LOSS vs. FREQUENCY
(When TX-ANT1 and ANT2-RX are ON)

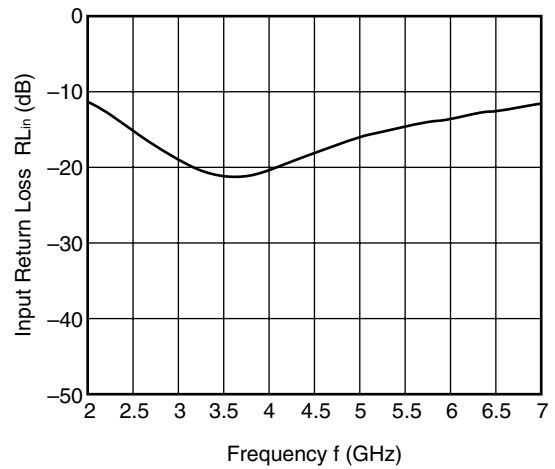

Remark The graphs indicate nominal characteristics.

OUTPUT POWER vs. INPUT POWER
(f = 2.4 GHz)

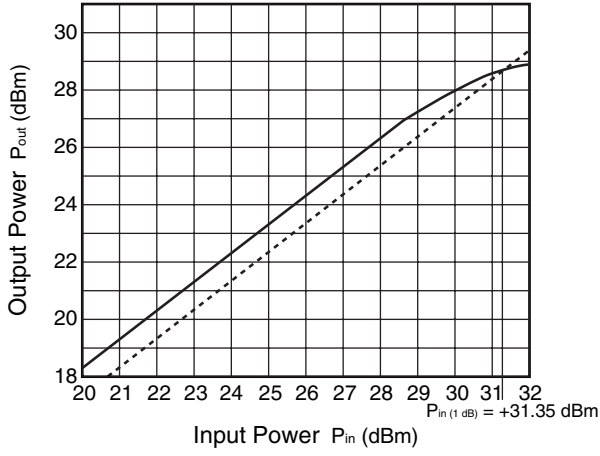

OUTPUT POWER vs. INPUT POWER
(f = 5.8 GHz)

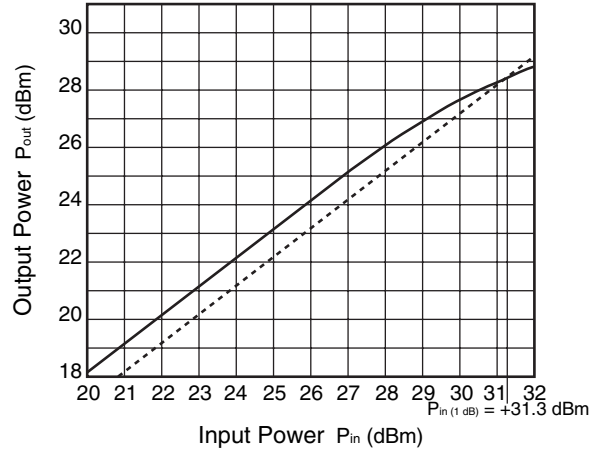

Remark The graphs indicate nominal characteristics.

★ **RECOMMENDED SOLDERING CONDITIONS**

This product should be soldered and mounted under the following recommended conditions. For soldering methods and conditions other than those recommended below, contact your nearby sales office.

Soldering Method	Soldering Conditions	Condition Symbol
Infrared Reflow	Peak temperature (package surface temperature) : 260°C or below Time at peak temperature : 10 seconds or less Time at temperature of 220°C or higher : 60 seconds or less Preheating time at 120 to 180°C : 120±30 seconds Maximum number of reflow processes : 3 times Maximum chlorine content of rosin flux (% mass) : 0.2%(Wt.) or below	IR260
Wave Soldering	Peak temperature (molten solder temperature) : 260°C or below Time at peak temperature : 10 seconds or less Preheating temperature (package surface temperature) : 120°C or below Maximum number of flow processes : 1 time Maximum chlorine content of rosin flux (% mass) : 0.2%(Wt.) or below	WS260
Partial Heating	Peak temperature (pin temperature) : 350°C or below Soldering time (per side of device) : 3 seconds or less Maximum chlorine content of rosin flux (% mass) : 0.2%(Wt.) or below	HS350

Caution Do not use different soldering methods together (except for partial heating).

When the product(s) listed in this document is subject to any applicable import or export control laws and regulation of the authority having competent jurisdiction, such product(s) shall not be imported or exported without obtaining the import or export license.

- **The information in this document is current as of February, 2005. The information is subject to change without notice. For actual design-in, refer to the latest publications of NEC's data sheets or data books, etc., for the most up-to-date specifications of NEC semiconductor products. Not all products and/or types are available in every country. Please check with an NEC sales representative for availability and additional information.**
 - No part of this document may be copied or reproduced in any form or by any means without prior written consent of NEC. NEC assumes no responsibility for any errors that may appear in this document.
 - NEC does not assume any liability for infringement of patents, copyrights or other intellectual property rights of third parties by or arising from the use of NEC semiconductor products listed in this document or any other liability arising from the use of such products. No license, express, implied or otherwise, is granted under any patents, copyrights or other intellectual property rights of NEC or others.
 - Descriptions of circuits, software and other related information in this document are provided for illustrative purposes in semiconductor product operation and application examples. The incorporation of these circuits, software and information in the design of customer's equipment shall be done under the full responsibility of customer. NEC assumes no responsibility for any losses incurred by customers or third parties arising from the use of these circuits, software and information.
 - While NEC endeavours to enhance the quality, reliability and safety of NEC semiconductor products, customers agree and acknowledge that the possibility of defects thereof cannot be eliminated entirely. To minimize risks of damage to property or injury (including death) to persons arising from defects in NEC semiconductor products, customers must incorporate sufficient safety measures in their design, such as redundancy, fire-containment, and anti-failure features.
 - NEC semiconductor products are classified into the following three quality grades:
 "Standard", "Special" and "Specific". The "Specific" quality grade applies only to semiconductor products developed based on a customer-designated "quality assurance program" for a specific application. The recommended applications of a semiconductor product depend on its quality grade, as indicated below. Customers must check the quality grade of each semiconductor product before using it in a particular application.
 "Standard": Computers, office equipment, communications equipment, test and measurement equipment, audio and visual equipment, home electronic appliances, machine tools, personal electronic equipment and industrial robots
 "Special": Transportation equipment (automobiles, trains, ships, etc.), traffic control systems, anti-disaster systems, anti-crime systems, safety equipment and medical equipment (not specifically designed for life support)
 "Specific": Aircraft, aerospace equipment, submersible repeaters, nuclear reactor control systems, life support systems and medical equipment for life support, etc.
- The quality grade of NEC semiconductor products is "Standard" unless otherwise expressly specified in NEC's data sheets or data books, etc. If customers wish to use NEC semiconductor products in applications not intended by NEC, they must contact an NEC sales representative in advance to determine NEC's willingness to support a given application.
- (Note)
- (1) "NEC" as used in this statement means NEC Corporation, NEC Compound Semiconductor Devices, Ltd. and also includes its majority-owned subsidiaries.
 - (2) "NEC semiconductor products" means any semiconductor product developed or manufactured by or for NEC (as defined above).

M8E 00.4-0110

<p>Caution</p>	<p>GaAs Products</p>	<p>This product uses gallium arsenide (GaAs). GaAs vapor and powder are hazardous to human health if inhaled or ingested, so please observe the following points.</p> <ul style="list-style-type: none"> • Follow related laws and ordinances when disposing of the product. If there are no applicable laws and/or ordinances, dispose of the product as recommended below. <ol style="list-style-type: none"> 1. Commission a disposal company able to (with a license to) collect, transport and dispose of materials that contain arsenic and other such industrial waste materials. 2. Exclude the product from general industrial waste and household garbage, and ensure that the product is controlled (as industrial waste subject to special control) up until final disposal. • Do not burn, destroy, cut, crush, or chemically dissolve the product. • Do not lick the product or in any way allow it to enter the mouth.
-----------------------	----------------------	---

► For further information, please contact

NEC Compound Semiconductor Devices, Ltd. <http://www.ncsd.necel.com/>

E-mail: salesinfo@ml.ncsd.necel.com (sales and general)

techinfo@ml.ncsd.necel.com (technical)

Sales Division TEL: +81-44-435-1588 FAX: +81-44-435-1579

NEC Compound Semiconductor Devices Hong Kong Limited

E-mail: ncsd-hk@elhk.nec.com.hk (sales, technical and general)

Hong Kong Head Office TEL: +852-3107-7303 FAX: +852-3107-7309

Taipei Branch Office TEL: +886-2-8712-0478 FAX: +886-2-2545-3859

Korea Branch Office TEL: +82-2-558-2120 FAX: +82-2-558-5209

NEC Electronics (Europe) GmbH <http://www.ee.nec.de/>

TEL: +49-211-6503-0 FAX: +49-211-6503-1327

California Eastern Laboratories, Inc. <http://www.cel.com/>

TEL: +1-408-988-3500 FAX: +1-408-988-0279